

# Single A10 1150 Prodigy™ Logic Module

The Single A10 1150 Prodigy FPGA Prototyping Logic Module is based on Intel Arria 10 GX1150 FPGA. The Single A10 Prodigy Logic Module is ideally suited for high-performance computing applications as well as prototyping small to medium sized SoCs. The Single A10 1150 Logic Module's compact size allows for flexibility and portability. The System is integrated with S2C's market-leading, vast library of daughter cards to quickly build prototype targets.

## Highlights

- Large Capacity and Scalability with 1,150K Logic Elements, 53Mbs of M20K memory, and 3,036 DSP resources and ability to connect multiple boards together for even greater capacity
- 44 Gigabit Transceivers that can run up to 16Gbps
- 576 high-performance I/Os through 4 Prodigy Connectors that supports a variety of daughter cards
- Low-cost parallel system integration and software development

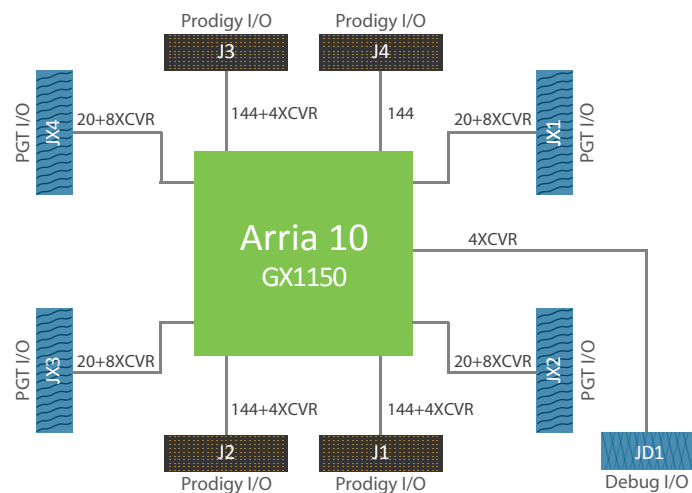

Single A10 1150 Prodigy Logic Module I/O Architecture

## Features

### Large Capacity & Scalability

- 1,150K Logic Elements
- 53 Mb M20K memory
- 3,036 DSP resource
- Multiple Logic Modules can be conveniently connected together to expand capacity through the use of interconnection modules or cables
- Up to 8GB DDR4/DDR3 memory through optional memory modules on J3 and J4 connectors

### High Performance

- Up to 80W of power for an FPGA
- Equal trace length for I/Os from same I/O connector
- 44 Gigabit Transceivers that can run up to 16Gbps

### Flexible & Powerful I/Os

- 576 high-performance I/O pins and 12 Gigabit transceivers through 4 Prodigy connectors
- I/O voltage can be adjusted to 1.2V, 1.35V, 1.5V or 1.8V through runtime software in GUI with 4 status LEDs on-board to indicate I/O voltage
- 32 Gigabit transceivers and 80 GPIOs through 4 PGT I/O connectors

### High Reliability

- Screw-lock design to high-speed I/O connectors
- Self-Tests – Isolate design issues from board issues conveniently with a software GUI
- Monitoring of on-board voltage, current and temperature with a software GUI
- Automatic shut-down upon detection of over-current, over-voltage or over-temperature

## Features

### Advanced Clock Management

#### Standalone Mode

- 6 Global clocks to be selected from
  - 6 programmable clock sources (0.16 ~ 350MHz)
  - 5 pairs of external clocks through MMCX connectors
  - 1 OSC socket
- 3 design clock outputs through 3 pairs of MMCX connectors
- 2 global resets sourced from push button or MMCX
- Two dedicated LVDS TDM clocks when using pin-multiplexing through S2C Player Pro software, one clock is fixed to 200MHz and the other clock is adjustable (0.16 ~ 350MHz)
- 1 global reset sourced from on board push button or runtime software in GUI

#### Multi-Board Mode

- 6 Global clocks to be selected from
  - 6 local programmable clock sources (0.16 ~ 350MHz)
  - 6 global clock resources
- 3 feedback clocks can be output to global clock sources
- Dedicated LVDS TDM clock(s) when using pin-multiplexing through S2C Player Pro software
- 2 global resets sourced from global reset sources

### Ease-of-Use

- Multiple FPGA configuration options through Ethernet port, USB port, JTAG and micro SD card
- Remote power on/off/recycle through Ethernet
- Auto detection of daughter cards and cables
- Virtual SWs & LEDs for simple tasks such as changing a setting or indicating a condition remotely
- User Test Area – LEDs, Push Buttons, Switches and Pin Headers for testing and debugging
- On-board battery charging circuit makes FPGA bin file encryption easy
- Optional ProtoBridge™ AXI software to co-model with software/simulation models at the transaction-level
- Optional S2C design implementation & debug software
- Optional Prodigy Multi-Debug Module (MDM) for the concurrent debugging of multiple FPGAs
- Compatible with S2C's off-the-shelf pre-tested daughter boards

## Modular and Portable Architecture

The Single A10 1150 Prodigy Logic Module Chassis System is the lowest profile enclosure on the market and the only one that includes all components – FPGA board, extendable power control module, and power supply – for maximum flexibility, durability, and portability. The modular system can be extended and upgraded into a dual or quad system.

- Flexible extension to securely attach accessories without increasing physical profile or intruding other parts of system
- Open chassis concept allows better heat dissipation
- Secure connections to daughter cards and other A10 Logic Modules
- Compact form factor: 220mm × 275mm × 94mm ( L × W × H )



Single A10 1150 Prodigy Logic Module 45° View